

# Next Generation NC Program Operation with VERICUT Version 9.0

Platform powered physics-based NC program optimization

# Takeaways

## What you need to know

### Takeaway #1

CGTech's VERICUT software is the recognized industry standard for simulating CNC machining—detecting errors, potential collisions, and areas of inefficiency.

### Takeaway #2

CGTech's Version 9.0 delivers a new graphics interface that renders graphics faster with more realistic and crisper views of cutting processes, machines, and machined material.

### Takeaway #3

Physics-based Optimization with VERICUT Force reduces machining times of new and existing NC programs. Force optimization reduces delivery times, increases capacity (throughput), improves margins and profits, provides quote price / bid price reduction, improves part-to-part and job-to-job consistency regardless of NC programmer or CAM methods used to create NC programs.

### Takeaway #4

VERICUT Additive simulates additive manufacturing (AM) and hybrid machining operations in any order, and can review the whole additive manufacturing process through extensive verification and optimized machining for better and faster AM parts.

### Takeaway #5

VERICUT Composites gives composite part designers complete control over their part build. With a wide variety of path laying algorithms, engineers can ensure that they capture the design intent of their composite work piece.

Takeaways

Introduction

Vericut

VERICUT User Interface

VERICUT Enhancements

Force

Force Benefits

Additive

Additive Droplet Technology

Additive Benefits

Composites

VERICUT Connectivity

VERICUT Interoperability

Conclusion



# Introduction

## Who is CGTech?

Since 1988 CGTech's flagship product, VERICUT software, has become the industry standard for simulating CNC machining by detecting errors, potential collisions, or areas of inefficiency.

VERICUT is used by companies of all sizes, universities/trade schools, and government agencies in more than 55 countries. VERICUT enables NC programmers to reduce or eliminate the process of manually proving-out NC programs. It results in reduced scrap and rework. The program also optimizes NC programs to both save time and produce higher quality surface finish.

VERICUT simulates all types of CNC machine tools, including those from leading manufacturers such as Mazak, Makino, DMG / Mori Seiki, Okuma, etc. VERICUT runs standalone, but can also be integrated with all leading CAM systems.



**CGTech has 12 Offices and Over 180 Resellers Around the Globe**

Takeaways

Introduction

Vericut

VERICUT User Interface

VERICUT Enhancements

Force

Force Benefits

Additive

Additive Droplet Technology

Additive Benefits

Composites

VERICUT Connectivity

VERICUT Interoperability

Conclusion



## Simulation of NC subtractive and additive manufacturing processes

### Solids-Based Simulation

VERICUT is a 3D solids-based software solution that interactively simulates material removal and additive processes as directed by NC programs run on CNC machine tools. The solution is known for accurately depicting multi-axis milling/drilling/additive as well as multi-axis turning and combination mill-turn machining. It enables programmers to verify the accuracy and quality of their NC programs and the resulting parts created by them. Using VERICUT, NC programs are proven off-line, so inefficient motions or programming errors that could potentially ruin a part, damage a fixture or CNC machine, or break a cutting tool can be corrected before the program is run on a CNC machine tool.

VERICUT is equipped with NC program optimization capabilities. Based on a handful of tool performance parameters, VERICUT automatically determines the optimum safe cutting feed rate for each cut. Cycle time can be reduced significantly. Optimized feed rates also result in longer cutting tool life, fewer broken cutting tools and scrapped parts, better quality parts due to minimized cutter deflection, and a better finish on part surfaces and edges due to constant tool pressure.

VERICUT shows material removal at the workpiece level, but also simulates entire digital twin machine

tools as they appear on a shop floor. The simulation functions just as the real machines, revealing unexpected machine motions, accurate offset and control function handling, and detecting over-travel errors before they occur on the real CNC machine. Machine Simulation detects collisions and near-misses between machine

components such as axis slides, heads, turrets, rotary tables, spindles, tool changers, fixtures, work pieces, cutting tools, and other user-defined objects. Programmers can set up near-miss zones around the components to check for close calls.

“VERICUT paid for itself the first time we used it.”  
—Mr. Dave Watson, Manufacturing Engineer,  
Lockheed Martin Aeronautical

### Part Verification Example

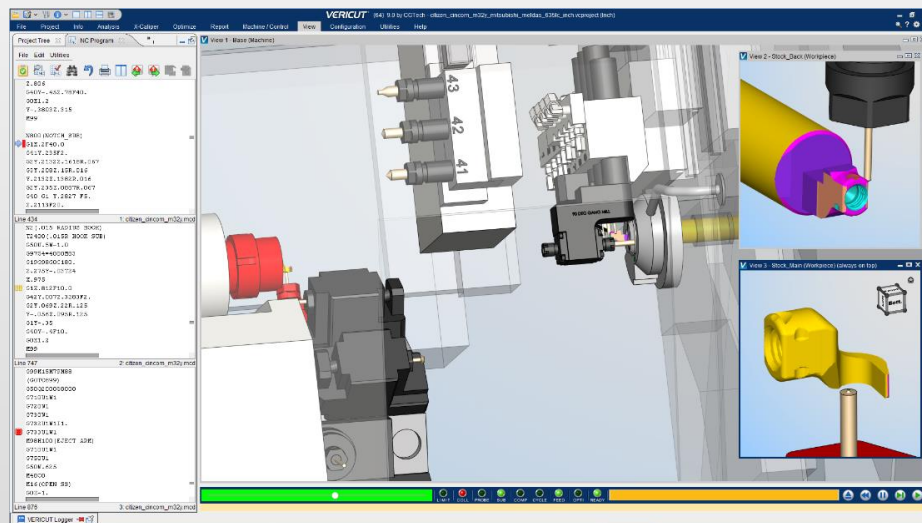

Takeaways

Introduction

Vericut

VERICUT User Interface

VERICUT Enhancements

Force

Force Benefits

Additive

Additive Droplet Technology

Additive Benefits

Composites

VERICUT Connectivity

VERICUT Interoperability

Conclusion



# VERICUT User Interface

## New graphics user interface enhances visualization and increases speed

### Enhanced Graphics & User Experience

Version 9.0 delivers a new graphics display which can render faster with more realistic and crisper views of cutting processes and machines, giving better understanding of the machine and machined material. Dramatic improvements in the view environment are delivered in Version 9.0 with the ability to manipulate the part and machine while the simulation is running, seamlessly switch view types or layouts, and change model translucency, colors, or other appearance properties at any time. New flexibility to use major functions i.e. (Section, X-Caliper and AUTO-DIFF) can be used in any view, increasing ease of use and user productivity to complete simulations faster.

X-Caliper has been enhanced with more options to measure the part or machine, and quickly create dimensioned setup images that can be incorporated in VERICUT's automatic reports to document the manufacturing process. Simulation speed has increased with the new graphics capability for NC program review and the free Reviewer application, which enable users to share how parts are manufactured with other individuals, departments, or companies—extending the value of the software throughout a company's manufacturing network.

The new Section window is easier to use with dynamic section plane locations and angle adjustments. More options are available for how section planes are defined, including  $\frac{3}{4}$  "wedge" section views, control over which objects are sectioned, and which views show sectioned objects.

"The savings on scrapped parts and material pays for the software many times over."  
—Mr. Stan Boland, Systems & Programming Manager, Brek Manufacturing

### X-Caliper Display Example

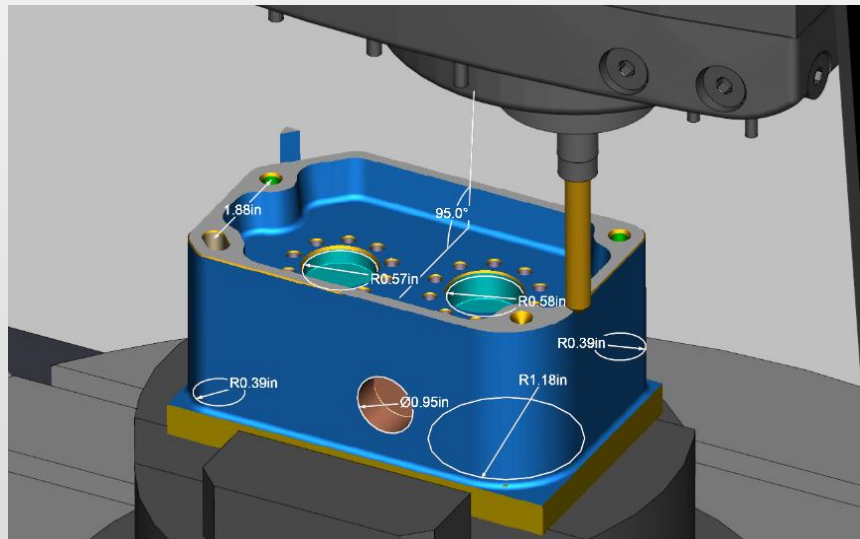

Image courtesy of CGTech

Takeaways

Introduction

Vericut

VERICUT User Interface

VERICUT Enhancements

Force

Force Benefits

Additive

Additive Droplet Technology

Additive Benefits

Composites

VERICUT Connectivity

VERICUT Interoperability

Conclusion



# VERICUT Enhancements

## New capabilities improve user productivity

Mill-Turn has been enhanced adding Multi Tool Station for turret lathes providing easier setup for an arrangement of cutting tools through a turret index position and the ability to activate a tool for cutting via its offset, checking the tools for collisions with the parts such as fixtures or the machine. A new turret setup feature allows selecting tools from a list or dragging and dropping from VERICUT's Tool Manager.

Restart and Stop At capabilities allow rapid verification of changes made to the NC program by selecting any line in the NC program window where the display quickly processes to that line and displays the result graphically. Similarly, the stop-at line number option allows the process to stop at the selected line number which is useful in evaluating looping or branching programs.

"It's such a small price to pay to find out if something works or doesn't work. Simulation lets me know if I'm tearing my machine up, and VERICUT's AUTO-DIFF function lets me know if my part's good. And when I send the program to the customer, they'll use VERICUT to review how I ran the program and ensure that I'm cutting the part the way they wanted. It saves so much time, and so much money for everyone involved. It's a little crazy when you stop to think of all of the things that VERICUT can help you with. To me, it's probably the most valuable tool a programmer can have."

—Mr. Casey Carson, NC Programmer, NobleTek

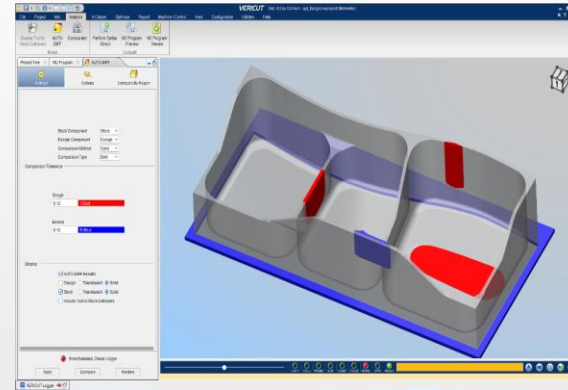

AUTO\_DIFF Results with Gouges Shown in Red and Excess Material in Blue

Images courtesy of CGTech

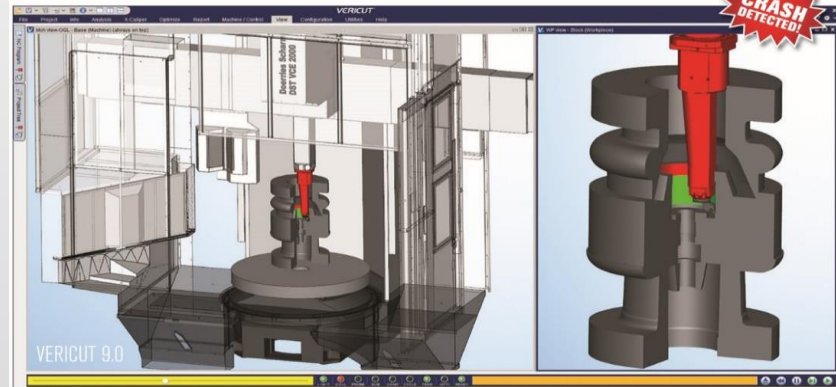

Section Enables Viewing Inside Machine Enclosures or Parts

Takeaways

Introduction

Vericut

VERICUT User Interface

VERICUT Enhancements

Force

Force Benefits

Additive

Additive Droplet Technology

Additive Benefits

Composites

VERICUT Connectivity

VERICUT Interoperability

Conclusion



# Force

## Physics-based optimization with VERICUT Force

VERICUT Force is a physics-based optimization strategy that was initially designed to improve the manufacturing of superalloy and high-technology products including helicopters, aircraft engines, and aerospace and defense systems. VERICUT Force is an optimization strategy that can be used independently and complementary to the standard and “optimized machining” strategies offered in CAM systems.

Force uses the physics of the machine, tool, and part to predict cutting forces and expose opportunities for improvements. Force recalculates cutting feed rates to achieve maximum ideal chip thickness and optimal cutter speed, while simultaneously protecting the machine and part from dangerous overloading. Keeping the chip thickness maximized and constant ensures that a tool is doing as much work as it can within any given cut and set of machining parameters. Ensuring that the tool is performing to its full potential. Other benefits include substantial time savings through higher cutting speeds, increased metal removal rates, reduced rubbing, less heat, and improved tool life.

CIMdata believes that the use of Force consistently throughout a shop could positively impact a machining shop’s competitiveness and increase its profitability.

Force uses a number of charts to depict to the user the areas of calculated changes, as shown in the figure. The difference between the original program and the Force optimized program is the opportunity for time and cost savings. Force uses a balanced approach for optimization: maximizing the chip thickness and keeping it constant while setting machine limits to prevent failure due to exceeding the maximum feedrate, the maximum force, and the maximum tool deflection.

“VERICUT saved us \$30,000 on one part alone.”  
—Mr. John Sweeney, NC Programmer, Schmiede Corporation

### Visual Analysis of Optimized NC Path and Improvement Opportunity

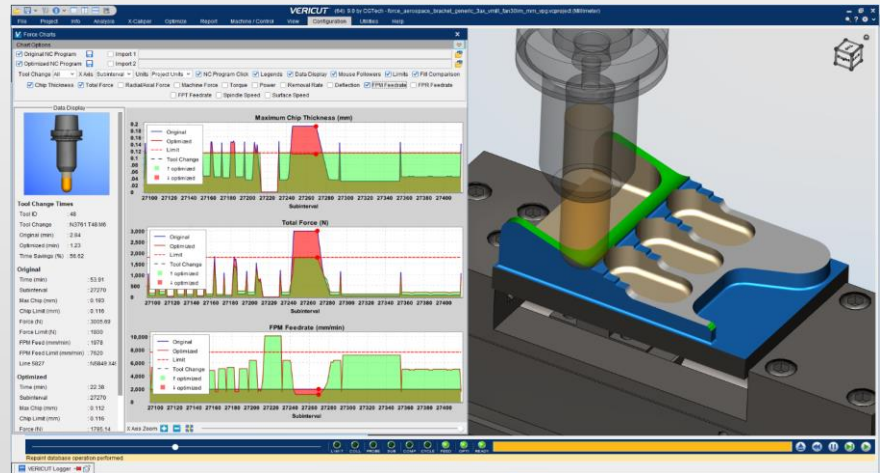

Image courtesy of CGTech



# Force Benefits

## Improved machining processes

Force benefits include:

- Significant cycle time savings, up to 25% or more
- User friendly (especially for NC programmers)
- Charted cutting condition information for NC program analysis and data driven decisions
- Fast analysis and iterations for testing various cutting scenarios for optimal NC programs
- Maximized and more consistent chip thickness throughout the machining process
- Prevention of undesirable cutting conditions like excessive feedrates
- Force reduction
- HP/Torque and tool deflection
- Improved cutting tool performance utilizing cutting tool technologies to their full potential
- Machining improvements that are balanced between tool life and speed

Force improves delivery times (beat due dates), increases capacity (increased throughput), improves margins (increased profits), provides the opportunity for quote price / bid price reduction, improves part-to-part and job-to-job consistency (regardless of NC programmer).

## Even Though Programmers Believe Their CAM Systems Create “Good” NC Programs, Tremendous Opportunity Exists for Those that Look Deeper

*Image courtesy of CGTech*



“I used Force on a program that I’d already optimized with a popular CAM system and Force lopped off (an additional) 40% of cycle time on the first go. It was pretty impressive to watch. We have machining application experts here with 15 to 25 years of experience, and they are invariably amazed by what Force can do.”

—Mr. John Giraldo, Aerospace Engineer, Sandvik Coromant

Takeaways

Introduction

Vericut

VERICUT User Interface

VERICUT Enhancements

Force

Force Benefits

Additive

Additive Droplet Technology

Additive Benefits

Composites

VERICUT Connectivity

VERICUT Interoperability

Conclusion





# Additive

Additive allows programmers to review the whole additive manufacturing process

VERICUT's Additive module simulates both additive manufacturing and traditional CNC machining capabilities applied in any order. Simulating both processes together identify potential problems and inefficiencies that can occur when integrating AM methods. The user has access to detailed history stored with VERICUT's Droplet technology, which saves programmers time by quickly identifying the source of errors with a single click. This additive capability shows realistic laser cladding and material deposition. It detects collisions between the machine and additive part, and finds errors, voids, and misplaced material.

VERICUT simulates the post-processed NC code (G-code program) that controls additive CNC machines, thereby ensuring proper usage of additive functions and laser parameters. Users can experiment with combining additive and metal removal (subtractive) processes to determine optimal safe hybrid manufacturing methods.

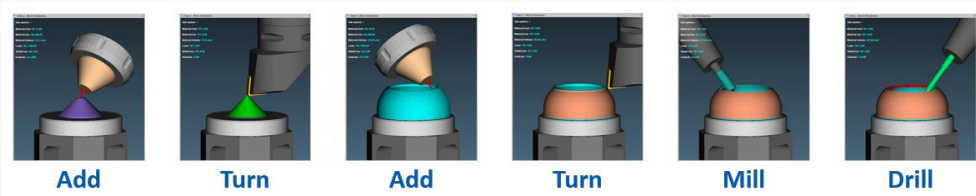

Stages of the Hybrid Manufacturing Process Simulation—With a Photo of the Finished Part

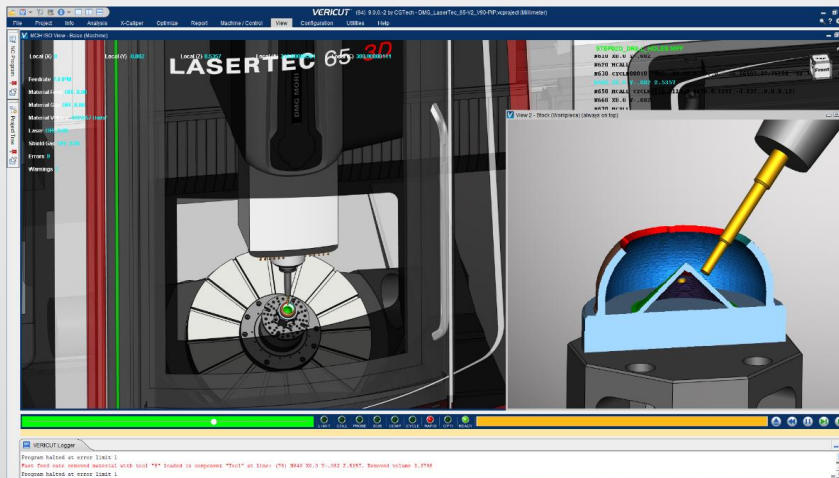

Simulation in VERICUT Additive

Images courtesy of CGTech/CCAT

Takeaways

Introduction

Vericut

VERICUT User Interface

VERICUT Enhancements

Force

Force Benefits

Additive

Additive Droplet Technology

Additive Benefits

Composites

VERICUT Connectivity

VERICUT Interoperability

Conclusion



# Additive Droplet Technology

Takeaways

Introduction

Vericut

VERICUT User Interface

VERICUT Enhancements

Force

Force Benefits

Additive

Additive Droplet Technology

Additive Benefits

Composites

VERICUT Connectivity

VERICUT Interoperability

Conclusion

## Additive also works with Force

Droplet technology saves time when investigating errors, voids, or misplaced material, since the source of the problem is revealed with just one-click. The realistic clad appearance is easily distinguished from cut stock machined features, therefore, providing the ability to clearly differentiate uncut surfaces that still require finish machining. This is essential for validating successful AM processes. The 5-Axis machining verification process of VERICUT accurately checks for errors on all 5-axis milling, turning, and additive laser sintering processes no matter how complex the machining operation or the order of operations.

To ensure that CGTech is developing software that solves real-world problems, CGTech partners with additive machine tool suppliers and advanced manufacturing technology centers, such as those shown. Currently, BeAM, OKUMA, Univ. of Sheffield/AMRC, and CCAT use VERICUT Additive from CGTech to help ensure their additive strategies will be successful, and protect valuable additive assets.

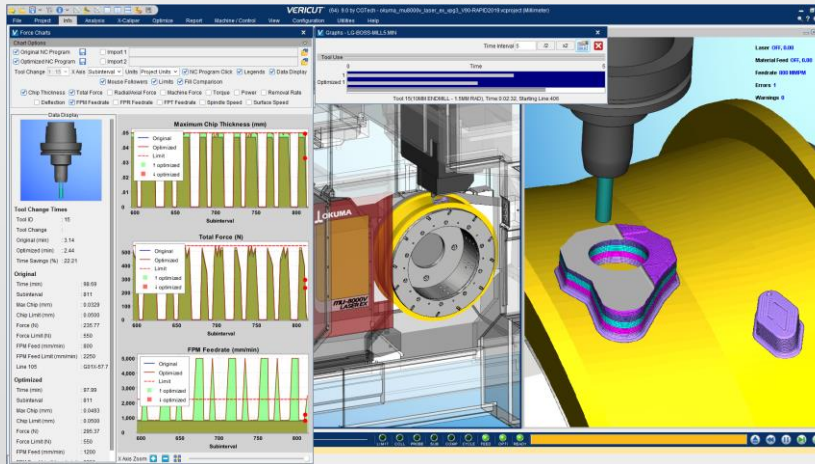

Image courtesy of CGTech

## CGTech Additive Machine Partners

### Additive Partners



Additive Used with Force Optimization



# Additive Benefits

## Additive streamlines additive manufacturing processes

VERICUT Additive verifies laser activity, power, material feed, and gas flow; verifying proper settings and use of laser-based additive manufacturing parameters as VERICUT reads the laser parameters, controls laser wattage, flow of carrier gas, and metallic powder specific to each job and material type.

VERICUT detects collisions between hybrid machined and additive parts. Identifying errors protects additive/hybrid machines and equipment from expensive crashes, voids in the product, and misplaced material. VERICUT detects collisions between the machine and additive part with its collision checking extended to cover additive parts as they are being built. This provides the ability to gauge potential problems with expensive hybrid machine laser equipment before production.

The user can visualize realistically the appearance of material deposition and machine features. Droplet technology makes it easy for programmers to identify the exact source of problems via a single click.

VERICUT Additive supports 5-axis milling, turning, and additive laser sintering and can simulate G-code programs for hybrid machines.

### Simulation of 5-Axis 3D Additive Accurately Depicts Build Process and Detects Potential Crashes

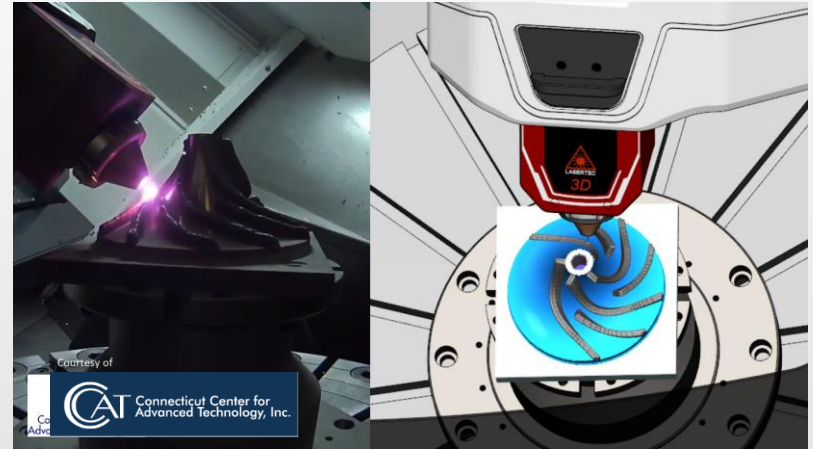

Images courtesy of CGTech/CCAT

### Finished Part

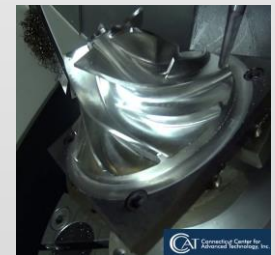

“The savings on scrapped parts and material pays for the software many times over.”  
—Mr. Stan Boland, Systems & Programming Manager, Brek Manufacturing

Takeaways

Introduction

Vericut

VERICUT User Interface

VERICUT Enhancements

Force

Force Benefits

Additive

Additive Droplet Technology

Additive Benefits

Composites

VERICUT Connectivity

VERICUT Interoperability

Conclusion



# Composites

## Programming & simulation software for automated fiber placement & tape laying machines

The use of composite material in a manufacturing setting is a widely-accepted practice. In some industries (automotive and aerospace) composites not only represents an established process, but one that continues to mature. However, the transition from hand layup to automated composites manufacturing is a difficult, time consuming, and costly endeavor with many barriers. CGTech has addressed these concerns by offering a very thorough product that creates paths to drive automated composites machines.

VERICUT composite applications are broken down into two segments: programming and simulation. Programming contains VCP (VERICUT Composite Programming), Knife Trimming Paths, Laser Projection, Probing, and ATL (Automated Tape Layout). Simulation contains VERICUT Composite

Simulation (VCS) and CNC machine probing.

VERICUT Composite Programming (VCP) reads CAD surfaces containing composites specific information such as ply boundaries, start points, axis systems, and ply angle. VCP pairs the data supplied in the CAD file with user-specified manufacturing requirements to construct a project file or blueprint for the part. VCP uses the information in the blueprint to fill designated areas with material and to generate paths for the machine to follow. VCP can calculate and balance material usage by keeping track of material on each composite material spool and altering head paths to re-distribute material as required. VCP also offers checks for material conformance with a heat map as shown in the left figure. The user can visualize ply angle deviations, steering violations,

and roller compression, as well as analyze gaps, overlaps, and material steering.

Once the user is satisfied with the analysis results, paths are linked to create layup sequences either automatically or manually. After linking, the data is sent to a machine specific post-processor, where the paths are converted to CNC code which the machine controller interprets as motion and event commands. To verify that the machine places material where the user anticipates, VCP generates exportable files for laser projectors that contain definitions for head paths, ply boundaries, safe restarts, tow gaps as well as other features. VCS then reads the CNC code as well as the laser projection data to ensure that the programs are collision free and that material is present in the appropriate regions.

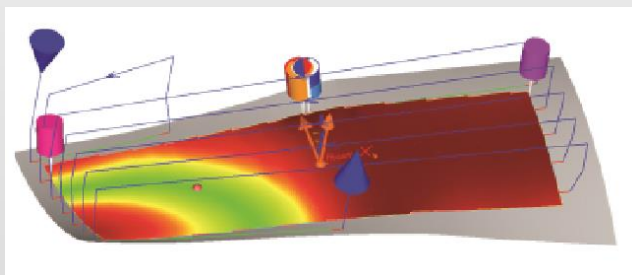

Heat Map of Material Conformance

### Composite Layout

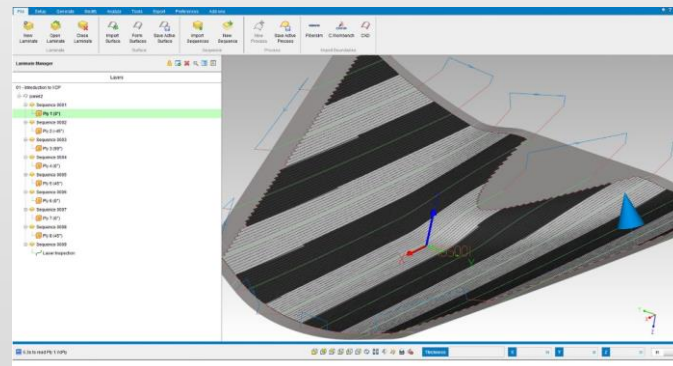

Images courtesy of CGTech

Takeaways

Introduction

Vericut

VERICUT User Interface

VERICUT Enhancements

Force

Force Benefits

Additive

Additive Droplet Technology

Additive Benefits

Composites

VERICUT Connectivity

VERICUT Interoperability

Conclusion



# VERICUT Connectivity

## VERICUT is integrated with the most popular CAM, Tooling, and PLM systems

CGTech offers VERICUT CAD/CAM Interfaces for most major CAD/CAM systems, as shown below. The interfaces tightly integrate VERICUT and the CAM systems to create optimal NC programs. They make verifying and optimizing NC programs and simulating CNC machines an easier and more efficient process. In most cases you can verify individual operations, a series of operations, or a

set of complete NC programs used in a variety of machining setups. All stock, fixture, and design geometry are automatically transferred to VERICUT in the correct orientation, along with the NC programs and tooling.

VERICUT runs independently, so users can continue working in their CAM system while simulating and optimizing their NC programs. VERICUT can also

verify and optimize NC programs from other CAM systems in CL, APT source, or post-processed G-code formats.



Current Supported Interfaces

Image courtesy of CGTech

Takeaways

Introduction

Vericut

VERICUT User Interface

VERICUT Enhancements

Force

Force Benefits

Additive

Additive Droplet Technology

Additive Benefits

Composites

VERICUT Connectivity

VERICUT Interoperability

Conclusion



# VERICUT Interoperability

Takeaways

Introduction

Vericut

VERICUT User Interface

VERICUT Enhancements

Force

Force Benefits

Additive

Additive Droplet Technology

Additive Benefits

Composites

VERICUT Connectivity

VERICUT Interoperability

Conclusion

## Accurate tooling representation contributes to a successful NC program simulation

VERICUT places the CAM system's part file on the virtual target machine. If a holding fixture was part of the collected data, both are placed in VERICUT in the applicable set-up position on the target machine. The as-designed part model enables users to verify there are no gouges committed against it and that all excess stock is removed as expected by the NC operations.

Geometry such as tooling and holders, can be replaced in VERICUT with more precise models. A user may want to replace the CAM system's tools with more accurate or correct versions to improve the quality of the simulation.

VERICUT includes a Tool Manager that supports full 3D models created either interactively or through the VERICUT CAD/CAM interface. Tools and tooling can also be defined from scratch using the Tool Manager, and any tool in the tool library can be edited with the Tool Manager, regardless of its source.

As with all software programs, the accuracy of the data input will directly affect the output. So, an accurate model of the cutting tool and holder is required for the effective and accurate simulation of the machining process. Most leading cutting tool manufacturers now make 3D solid model data available and VERICUT can load this model data for use in the simulation process. Many of these 3D models are available via the MachiningCloud App

providing access to data from over 40 tool related manufacturers and fixture suppliers. VERICUT's Tool Manager takes advantage of Machining Cloud metadata which can significantly simplify the configuration of tools for use in VERICUT. Suppliers including TDM, Zoller, WinTool, Speroni, and Kennametal's NOVO can also interface to the software, so tool offsets and exact dimensions can be applied to the simulation session. A tool definition example is shown below.

"Is there any interference between the toolholders and the vise? Did the program cut the part right? Is the spindle going to bump the workpiece? Did each axis go the direction you expected it to? There are all kinds of problems that can occur, but because the CAM software doesn't see the same thing the machine sees, there can be occasional surprises. VERICUT eliminates the wondering."  
—Chuck Maccomb, NC Programmer, Jemco Components and Fabrication Inc.

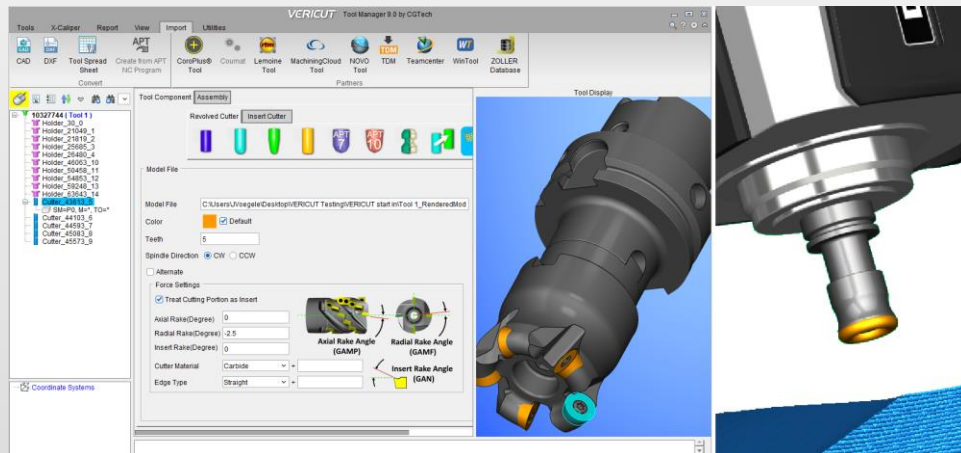

Tool Definition Example

Image courtesy of CGTech



# Conclusion

## CIMdata's final thoughts

By using the broad range of capabilities of CGTech VERICUT software to detect errors, locate potential collisions, and identify areas of inefficiency within NC programs, users can send their NC programs to the shop-floor with exceptional confidence, no matter how complex the CNC machine or the NC program.

Companies can use CGTech's products and services to achieve a means of asset protection for their machinery, equipment, and raw materials—minimizing unnecessary and avoidable rework, improving profitability, increasing on-time delivery performance, and realizing greater overall customer satisfaction.

Companies of any size can receive the benefits of validating their entire CNC machining environment and processes, identifying opportunities for process improvement and risk avoidance, all without committing or risking real business assets.

CGTech continues to expand the boundaries of NC verification with their Force capabilities and support for additive manufacturing combined with their established subtractive verification techniques.

VERICUT's broad range of capabilities make CGTech a preferred solution provider for industries as diverse as machine tools, automotive, aerospace, and medical instrument design and manufacturing.

For more information, visit CGTech at: <https://www.cgtech.com>

CGTech Corporate Headquarters  
9000 Research Drive  
Irvine, California 92618-4214  
Phone: (949) 753-1050  
FAX: (949) 753-1053

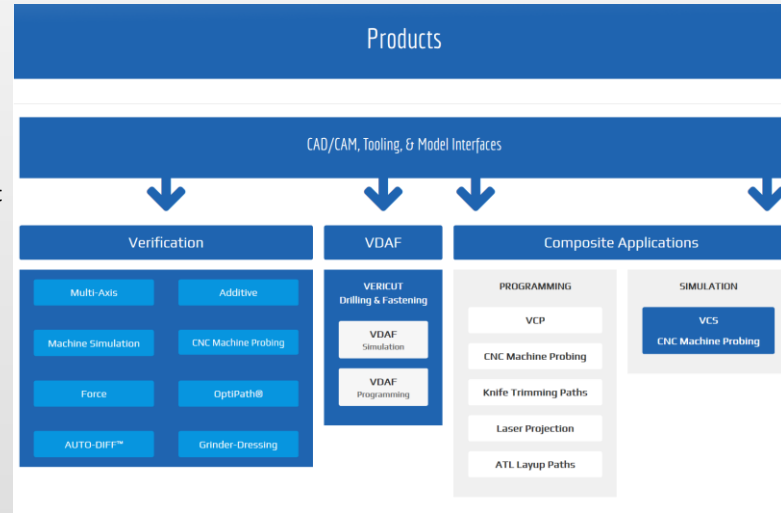

Global Leaders in PLM Consulting  
[www.CIMdata.com](http://www.CIMdata.com)

Takeaways

Introduction

Vericut

VERICUT User Interface

VERICUT Enhancements

Force

Force Benefits

Additive

Additive Droplet Technology

Additive Benefits

Composites

VERICUT Connectivity

VERICUT Interoperability

Conclusion

